

4100 SERIES

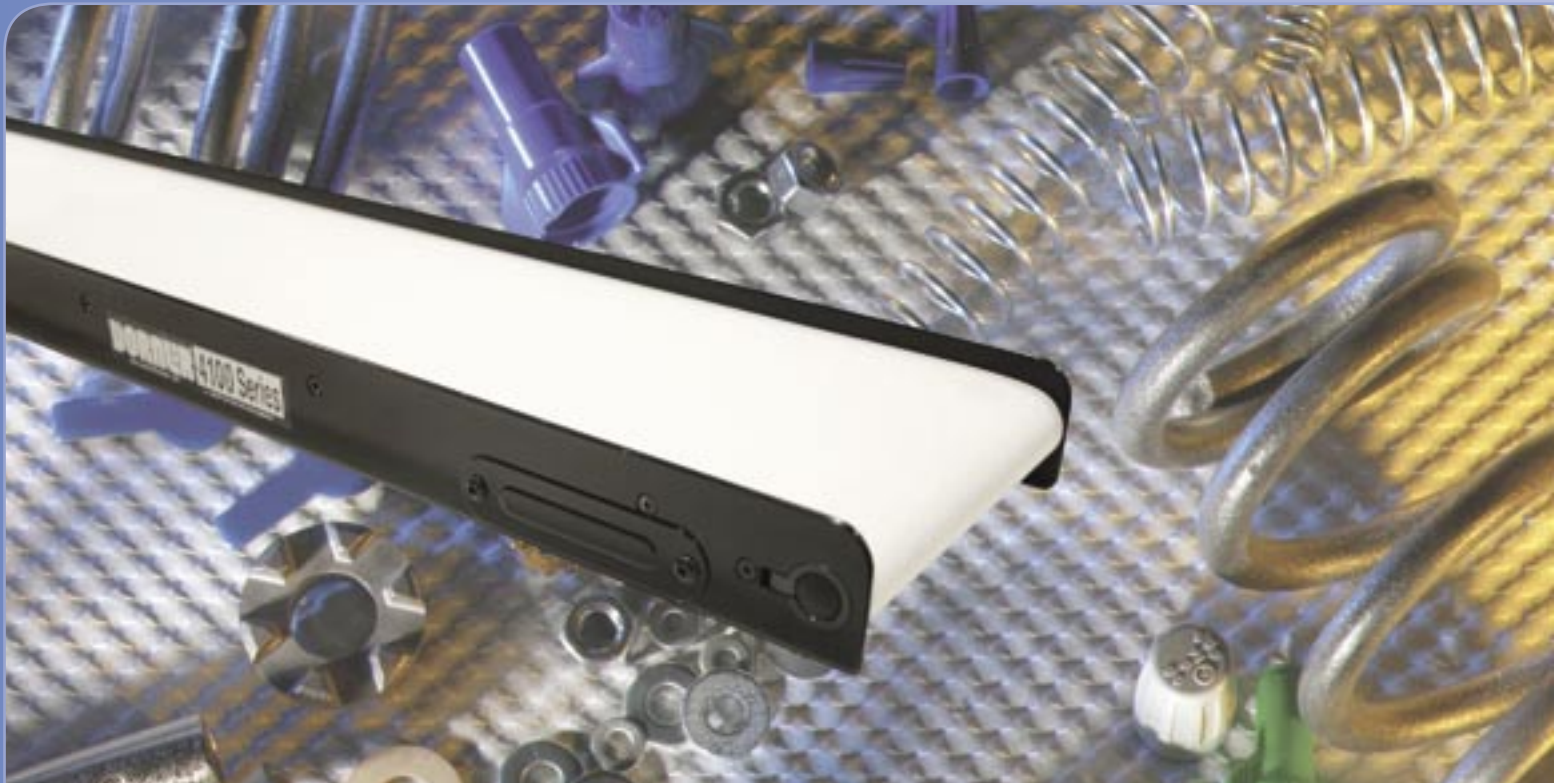

Specifications:

- Widths up to 12" (305)
- Lengths up to 6' (1,829)
- The 1" (25) diameter drive pulley.
- Load capacity up to 80 lbs.* (36kg).
- Belt speeds to 255 ft./min. (78 M/min.).

Applications:

- Metal Forming
- Metal Stamping
- Machined Part Handling

4100 SERIES INDEX

Flat Belt End Drive	130
Profiles	140
Belting	142
Gearmotor Mounting Packages	145
Gearmotors.....	152
Support Stands.....	160
Accessories	165
Performance Charts / Data	167

4100 SERIES: FLAT BELT END DRIVE



Applications:

- Metal Forming, Stamping
- Machined Part Handling

Note: 4100 Gearmotor mounting packages are available with metric fasteners only.

Specifications:

- .75" (19) minimum, 12" (305) maximum belt widths.
- 2' (610) minimum, 6' (1,829) maximum conveyor lengths.
- 12 - gauge roll formed steel frame.
- 1.5" (38) bottom of frame to top of belt.
- The 1" (25) diameter drive pulley turns approximately 3.4" (86) of belt per revolution.
- Load capacity up to 80 lbs.* (36kg).
- Belt speeds to 255 ft./min. (78 M/min.).
- SAE fasteners only, metric fasteners not available on the conveyor.
- Do not index or reverse .75" (19) and 1.75" (44) wide conveyors.

Features/Benefits:

- Mild steel 1-piece frame with .25" (6) thick bed plate for strength and durability.
- Durable baked enamel finish.
- Low maintenance fixed pulley centers with no belt tracking requirements.
- Magnetic models available.
- Wide variety of profiles and accessories.
- Durable .25" (6) thick bottom wiper removes debris from belt.
- Belt type and materials to match application requirements.

* Conveyor load capacity depends on conveyor size, incline, motor position, accumulated loads and other factors. See Performance Charts / Data section for details.

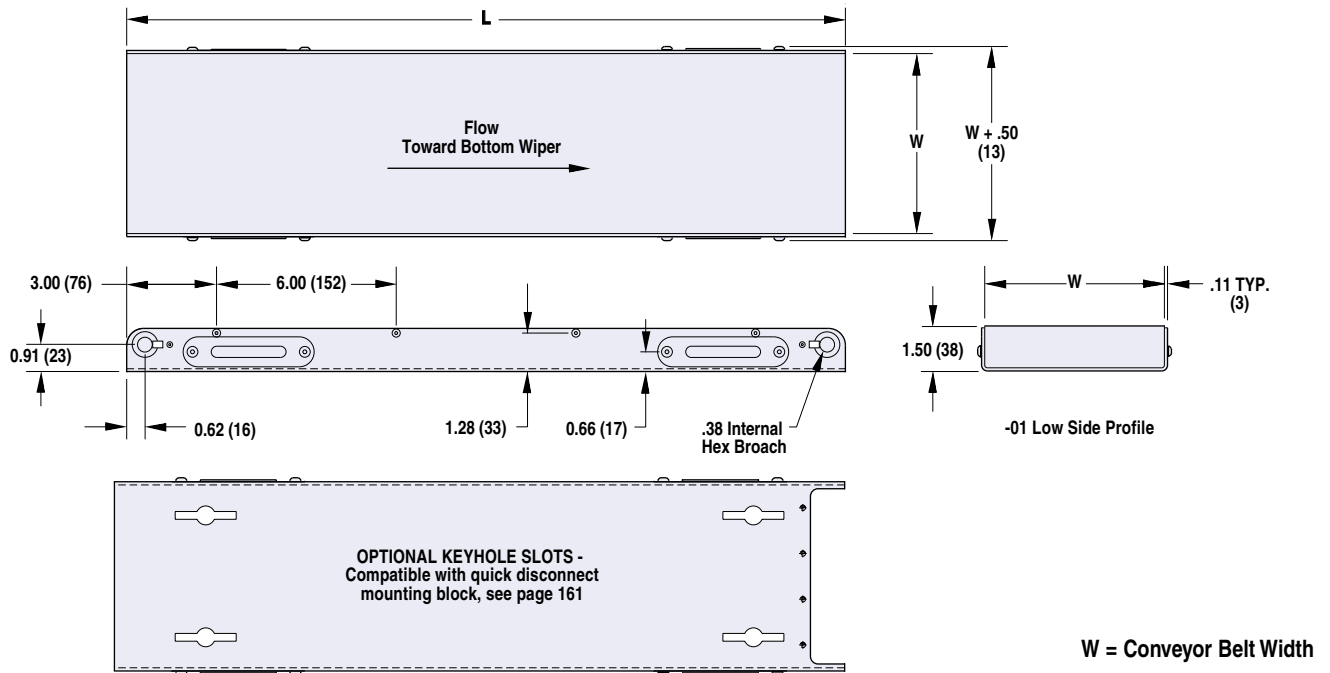

STANDARD SIZES							
Conveyor Width Reference	01	02	03	04	06	08	12
Conveyor Belt Width (W)	.75" (19)	1.75" (44)	2.75" (70)	3.75" (95)	6" (152)	8" (203)	12" (305)
Conveyor Length Reference	02		01 increments up to...			06	
Conveyor Length (L)	2' (610)		1' increments up to..			6' (1,829)	

ORDERING INFORMATION

4100 B 02 03 A 02 /02

- 4100 Series Conveyor
- 00 = Single End Wiper, DW = Double End Wiper
- Conveyor Width Reference
- Conveyor Length Reference
- Hex Broach Location: A, B, C or D
- Conveyor Profile. See page 141
- Belt Type. See pages 142

Drive Shaft Position

Since belts are being pulled, positions A & D are preferred. Pushing belts (B & C) reduce conveyor load capacity by approximately 66%.

Example: 4100B0203A02/02
Description: 4100 Series End Drive Conveyor 2" (44) wide x 3' (914) long with hex broach located in the A position, high side profile and general purpose belt.

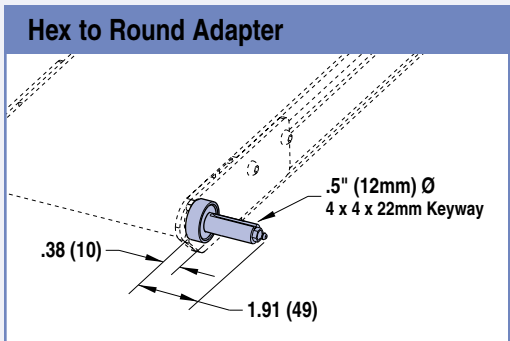

ORDERING INFORMATION: Hex to Round Adapter

43 - 38 - 02

- 4100 Series Conveyor
- Conveyor Width Reference:
 - 01 = .75" (19) wide (.5" diameter only)
 - 02 = 1.75" (44) wide
 - 03 = 2.75" (70) wide
 - 04 = 3.75" (95) to 12" (305) wide
- Shaft Diameter: 38 = .5", 48 = 12mm

Example: 4100-0203A02/02
Description: 4100 Series hex to round adapter for 1.75" (44) side conveyor, .5" diameter shaft.

Note: Dimensions are represented in inches, feet, and (millimeters).
 Due to the wide variety of drive set-ups and applications, point of installation guarding is the responsibility of the end user.

4100 & 6200 SERIES: PROFILES

4100 Series Profiles

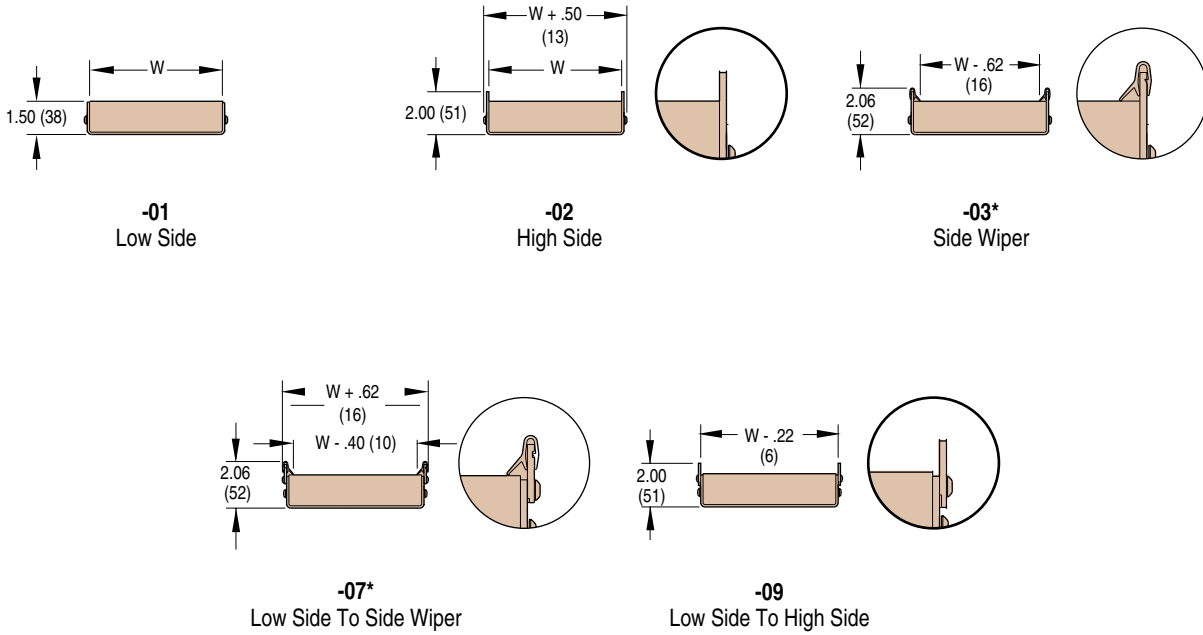

* = Do not use with High Friction Belts
 W = Conveyor Belt Width

ORDERING INFORMATION

Example: 4100-0203A02/02

Description: 4100 Series End Drive Conveyor 2" (44) wide x 3' (914) long with hex broach located in the A position, high side profile and general purpose belt.

Dimensions are represented in inches, and (millimeters).

Due to the wide variety of drive set-ups and applications, point of installation guarding is the responsibility of the end user.

4100 & 6200 SERIES: STANDARD BELTING



Standard Belt Selection Guide

Standard belt material is stocked at Dorner, then cut & spliced at the factory for fast conveyor shipment.

Belt Type - Finger Splice	Belt Type - Plastic Clipper	Belt Type - Metal Clipper	Belt Specifications	Thickness	Surface Material	Carcass Material	Maximum Part Temp.	Coefficient of Friction	FDA Approved	Anti-Static	Static Conductive	Chemical Resistant	Special Characteristics or Applications
01	A1	1A	FDA Accumulation	.063" (1.6)	Urethane	Polyester	176°F (80°C)	Low	x	x		Good	Packaging, clean room & inspection
02	A2	2A	General Purpose	.071" (1.8)	Urethane	Polyester	212°F (100°C)	Med	x	x		Good	Most versatile belt offering
03	A3	3A	FDA High Friction	.063" (1.6)	Urethane	Polyester	176°F (80°C)	High	x	x		Good	Packaging, clean room & inspection
05	A5	5A	Accumulation	.047" (1.2)	Urethane	Polyester	212°F (100°C)	V-Low	x	x		Good	Accumulation of products
06		6A	Electrically Conductive	.063" (1.6)	Urethane	Polyester	230°F (110°C)	Low		x	x	Good	Electronics Handling
08	A8	8A	High Friction	.083" (2.1)	PVC	Polyester	158°F (70°C)	V-High		x		Poor	Conveys up to 35° inclines*

Note: See below for splice details. Plastic Clipper splice requires longer lead times. No Metal Clipper Splice on belts over 12" (305) wide.
*Incline varies due to factors like dust, fluids and part material.

Belt Splicing



Finger Splice

All belts are available with a standard Thermoformed finger splice. This splice makes the belt continuous and is virtually undetectable. Splice bonding methods vary by belt type. Consult factory for details.



Plastic Clipper*

An optional plastic clipper splice is available for quick removal of belts or when conveyors are installed in tight spaces. The clipper does not protrude above the belt surface.



Metal Clipper*

An optional metal clipper splice is also available for quick removal of belts or when conveyors are installed in tight spaces.

*See belt charts for compatibility. Not for use with 4100 Series, 6200 Series Gang Drive or 6200 Series with bottom wiper.

SPECIALTY BELTING



Specialty Belt Selection Guide

Specialty belt material is not stocked at Dorner and needs to be custom ordered for your special conveyor needs.

Belt Type with Finger Splice	Belt Type with Plastic Clipper	Belt Type with Metal Clipper	4100 Series	6200 Series	Belt Specifications	Belt Thickness	Surface Material	Maximum Part Temp.	Coefficient of Friction	FDA Approved	Chemical Resistance	Special Characteristics or Applications
			X		Heat Resistant	.05 (1.3)	Silicone	356°F (180°C)	Low		Good	
			X		Translucent & Nosebar, Accumulation	.02 (.51)	Urethane	212°F (100°C)	V-Low	x	Good	Back Lit inspection & Very Small Product Transfer
F4	4F	X	X		FDA Sealed Edge	.06 (1.5)	Urethane	176°F (80°C)	Low	x	Good	Packaging, clean room & inspection
F5	5F	X	X		FDA Sealed Edge	.06 (1.5)	Urethane	176°F (80°C)	High	x	Good	Packaging, clean room & inspection
	6F	X	X		Cut Resistant	.08 (2.1)	Urethane	212°F (100°C)	Med.		Good	Oily product release, Metal stamping
	7F	X	X		Cut Resistant	.10 (2.5)	Nitrile	176°F (80°C)	Med.		Poor	Felt-like, dry metal stamping, glass & ceramic
	8F	X			Cut Resistant	.06 (1.5)	Urethane	176°F (80°C)	Low		V-Good	Cross-linked surface, Gold colored
F9	9F	X	X		Color Contrasting	.06 (1.5)	PVC	158°F (70°C)	Med.		Poor	Black colored, hides overspray from ink jet
G0	0G	X	X		Color Contrasting	.06 (1.6)	Urethane	176°F (80°C)	Low	x	Good	Green colored
G1	1G	X	X		Color Contrasting	.05 (1.2)	Urethane	212°F (100°C)	Med.	x	Good	Blue colored
	3G	X	X		Electrically Conductive	.05 (1.2)	Urethane	140°F (60°C)	Low		Good	Static conductive, electronics handling
	4G		X		High Friction	.17 (4.4)	PVC	194°F (90°C)	V-High		Poor	Dark Green colored, rough top surface, product cushioning, incline / decline apps
	5G	X			Chemical Resistant	.05 (1.3)	Polypropylene	250°F (126°C)	Low	x	V-Good	V-Good Cut resistance, excellent product release
	6G	X	X		Chemical Resistant	.07 (1.7)	Polyester	212°F (100°C)	Med.	x	V-Good	Good Cut resistance, metal stamping apps
	7G		X		Low Friction Cleated	.06 (1.6)	Polyester	212°F (100°C)	n/a	x	Good	Excellent product release, consult factory for part number and how to specify low friction

Note: Plastic Clipper splice requires longer lead times. No Metal Clipper Splice on belts over 12" (305) wide.

* Do not use with LPZ conveyor. ** 12" (305) wide conveyor maximum. *** Not available in 2" (51) wide. † 24" (610) wide conveyor maximum

ORDERING INFORMATION: Standard Flat & Specialty Belt

Example: 220M020300A0102

Description: 2200 Series End Drive Conveyor, 2" (51) wide x 3' (914) long with output shaft located in the A position, standard low sides, general purpose belt and English documentation.

GEARMOTOR MOUNTING PACKAGES

Gearmotor Mounting Package & Gearmotor Selection Steps

- Step 1:** Select a **Gearmotor Mounting Package**. For End drive conveyors, select a side, bottom, top or gang drive mount (pages 146 - 149). If a Center Drive conveyor is being outfitted, refer to the Center Drive section pages 150 & 151. Be sure to note if it is for a **90°** or **Parallel Shaft** Gearmotor.
- Step 2:** Using **Belt Speed & Load** Requirements, determine the required **Gearmotor Type** (Light, Heavy or Standard) for your application using the chart below.
- Step 3:** Find the appropriate set of Belt Speed Charts (pages 148 & 151) for the Mounting Package you selected and choose between the **Fixed** or **Variable Speed** chart.
- Step 4:** Go down the first column of the Belt Speed Chart and locate the required **Belt Speed** for your application. If the desired belt speed is not listed, round up to the next higher speed.
(Dorner offers much more than just the belt speeds listed in the tables, contact the factory for complete details)
- Step 5:** From the row containing your required **Belt Speed**, check to be sure that speed is available for the **Mount Package** you chose. (End Drive Only - Top, Bottom or Side)
- Step 6:** Use the Drive / Driven Pulley Kit combination to complete your Mounting Package Part Number
- Step 7:** Note the **RPM from Gearmotor**, it will be needed to select the correct Gearmotor from the Gearmotor Chart.
- Step 8:** Reference the **Gearmotor Chart #** to locate a compatible Gearmotor Chart on Pages 153-157. Be sure to select a Gearmotor Chart to match your **Gearmotor Type** (Light, Standard or Heavy) and your **Mounting Package** while meeting your electrical requirements.
(Red = Parallel Shaft or Blue = 90°)
- Step 9:** Using the **RPM from Gearmotor** (Step 6), locate the **Part Number** for your Gearmotor from the Gearmotor Table.

GEARMOTOR TYPE	Conveyor Load - Lbs (Kg)											
	10 (4.5)	20 (9.1)	30 (13.6)	40 (18.2)	50 (22.7)	60 (27.3)	70 (31.8)	80 (36.4)	90 (40.9)	100 (45.5)	110 (50)	120 (54.5)
	Light Load	Standard Load	Heavy Load	Light Load	Standard Load	Heavy Load	Light Load	Standard Load	Heavy Load	Light Load	Standard Load	Heavy Load
Belt Speed - Ft/min (M/min)	0-15 (0-4.6)											
	16-30 (4.9-9.1)											
	31-45 (9.5-13.7)											
	46-60 (14-18.3)											
	61-75 (18.6-22.9)											
	76-90 (23.2-27.4)											
	91-110 (27.7-33.5)											
	111-130 (33.8-39.6)											
	131-150 (39.9-45.7)											
	151-175 (46-53.4)											
	176-200 (53.7-61)											
	201-225 (61.3-68.6)											
	226-250 (68.9-76.2)											
	251-275 (76.5-83.8)											

ORDERING INFORMATION: End Drive Mounting Packages

6 M B P S 06 A - 2828

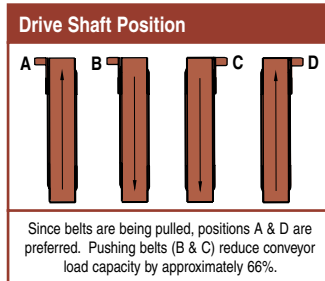
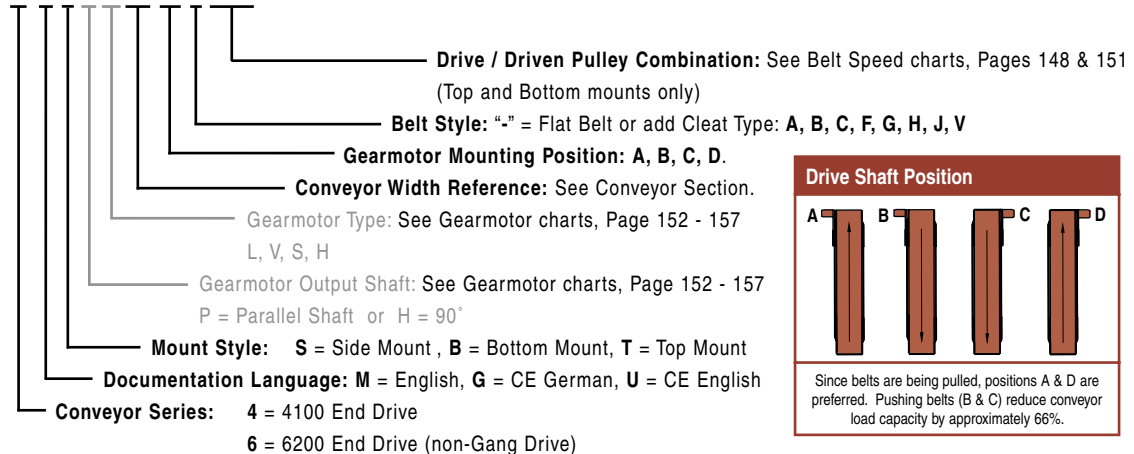

Example: 6MBPS06A-2828

Description: Bottom mount package with English documentation for 6" (152) wide 6200 series end drive conveyor. Configured for a parallel shaft, Standard load motor in the A1 mount position with a 28:28 drive / driven pulley combination.

4100 & 6200 SERIES: END DRIVE MOUNTING PACKAGES

Side Mount Package, 90° Gearmotor

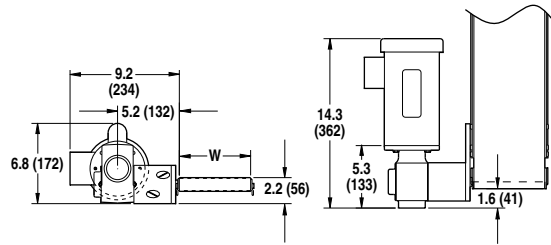

Standard load gearmotors only

- Includes : Gearmotor mounting bracket, coupling, coupling guard & mounting hardware

W = Conveyor Belt Width

Bottom Mount Package, 90° Gearmotor

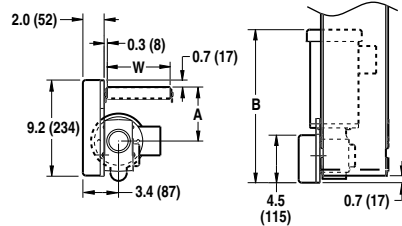

A: Standard Load Flat Belt = 5.2 (132)	B: Standard Load Flat Belt = 14.6 (371)
Standard Load Cleated Belt = 7.9 (199)	Standard Load Cleated Belt = 14.6 (371)
Heavy Load Flat Belt = 7.9 (199)	Heavy Load Flat Belt = 15.6 (395)
Heavy Load Cleated Belt = 7.9 (199)	Heavy Load Cleated Belt = 15.6 (395)

- Includes : Gearmotor mounting bracket, coupling, coupling guard & mounting hardware

W = Conveyor Belt Width

Top Mount Package, 90° Gearmotor

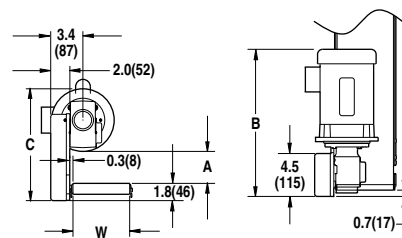

A: Standard Load = 3.8 (96)	B: Standard Load = 14.6 (371)	C: Standard Load = 11.1 (283)
Heavy Load = 3.4 (86)	Heavy Load = 15.6 (395)	Heavy Load = 11.8 (301)

- Includes : Gearmotor mounting bracket, coupling, coupling guard & mounting hardware

W = Conveyor Belt Width

90° Standard Load Gearmotor Location Options

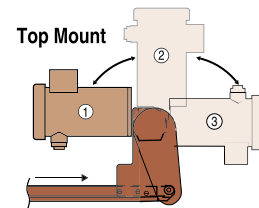
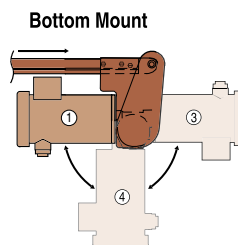
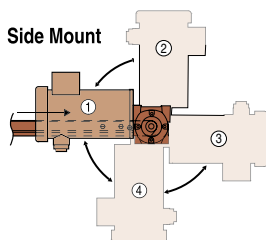

Notes:

- Position 1 recommended.
- Vertical positions 2 & 4 may require additional stabilizing bracket.
- Consult factory for details

See pages 152 - 157 for Gearmotor Selection

END DRIVE MOUNTING PACKAGES

Side Mount Package, Parallel Shaft Gearmotor

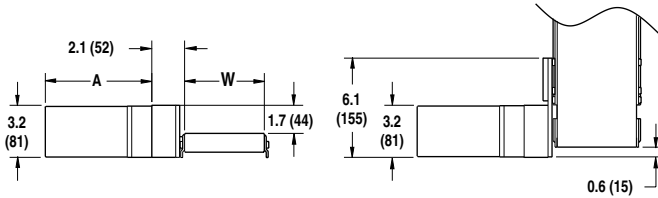

- A: Light Load, Fixed Speed = 4.6 (117)
- Light Load, Variable Speed = 6.7 (170)
- Light Load CE Fixed Speed = 7.2 (183)



Light load gearmotors only

- Includes : Gearmotor mounting bracket, coupling, coupling guard & mounting hardware

W = Conveyor Belt Width

Bottom Mount Package, Parallel Shaft Gearmotor

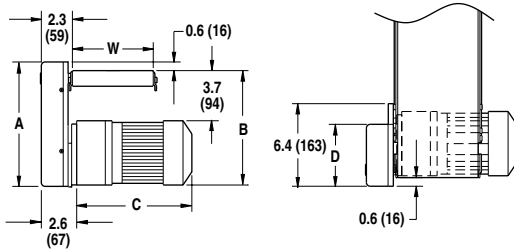

- | | |
|--------------------------------------------|--------------------------------------------|
| A: Light Load Flat Belt = 6.9 (175) | C: Light Load Flat Belt = 6.7 (170) |
| Light Load Cleated Belt = 8.9 (226) | Light Load Cleated Belt = 6.7 (170) |
| Standard Load Flat Belt = 9.2 (234) | Standard Load Flat Belt = 10.5 (267) |
| Standard Load Cleated Belt = 9.2 (234) | Standard Load Cleated Belt = 10.5 (267) |
| B: Light Load Flat Belt = 6.2 (158) | D: Light Load Flat Belt = 6.1 (155) |
| Light Load Cleated Belt = 8.3 (211) | Light Load Cleated Belt = 5.6 (142) |
| Standard Load Flat Belt = 8.5 (216) | Standard Load Flat Belt = 4.6 (116) |
| Standard Load Cleated Belt = 10.3 (262) | Standard Load Cleated Belt = 4.6 (116) |



- Includes : Gearmotor mounting bracket, coupling, coupling guard & mounting hardware

W = Conveyor Belt Width

Top Mount Package, Parallel Shaft Gearmotor

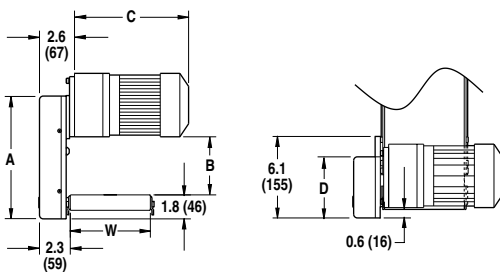

- | | |
|----------------------------------|----------------------------------|
| A: Light Load = 8.9 (226) | C: Light Load = 6.7 (170) |
| Standard Load = 9.2 (234) | Standard Load = 10.5 (267) |
| B: Light Load = 3.3 (84) | D: Light Load = 5.6 (142) |
| Standard Load = 4.3 (110) | Standard Load = 4.6 (116) |



- Includes : Gearmotor mounting bracket, coupling, coupling guard & mounting hardware

W = Conveyor Belt Width

4100 & 6200 SERIES: END & GANG DRIVE BELT SPEED CHARTS

Refer to the Gearmotor Selection Steps on Page 145
for instructions on using the Belt Speed Charts.

Fixed Speed									
Belt Speed		RPM From Gearmotor	Mount Package		Pulley Kit		Gearmotor Chart #		
Ft/min	M/min		Top & Bottom	Side	Drive Pulley	Driven Pulley	Light Load	Standard Load	Heavy Load
2	0.6	10	X		22	32		5	
3	0.9	10	X		28	28		5	
5	1.5	10	X		44	22		5	
6	1.8	29	X		19	32		4, 5	12, 13
10	3.0	29	X	X	28	28		4, 5	12, 13
13	4.0	42	X		28	32	1		
15	4.6	42	X	X	28	28	1		
15	4.6	43	X	X	28	28		4	12, 13
16	4.9	29	X		44	28		4, 5	12, 13
21	6.4	42	X		32	22	1		
24	7.3	43	X		44	28		4	12, 13
29	8.8	42	X		44	22	1		
30	9.1	86	X	X	28	28		4, 5	12, 13
35	10.7	100	X	X	28	28	1		
48	14.6	86	X		44	28		4, 5	12, 13
55	16.8	100	X		44	28	1		
61	18.6	173	X	X	28	28		4, 5	12, 13
95	29.0	173	X		44	28		4, 5	12, 13
104	31.7	173	X		48	28		4, 5	12, 13
121	36.9	345	X	X	28	28		4, 5	12, 13
138	42.1	345	X		32	28		4, 5	12, 13
176	53.6	345	X		32	22		4, 5	12, 13
208	63.4	345	X		48	28		4, 5	12, 13
242	73.8	345	X		44	22		4, 5	12, 13
264	80.5	345	X		48	22		4, 5	12, 13

CE Gearmotor RPM at 50 Hz									
Belt Speed	RPM From Gearmotor	Mount Package	Pulley Kit	Gearmotor Chart #					
Ft/min	M/min	Top & Bottom	Side	Drive Pulley	Driven Pulley	Light Load	Standard Load	Heavy Load	
5	1.5	23*	X		19	32		6	
8	2.4	23*	X	X	28	28		6	
12	3.7	35*	X	X	28	28		6	
19	5.8	35*	X		44	28			
21	6.4	41*	X		32	22	2		
25	7.6	70*	X	X	28	28		6	
39	11.9	70*	X		44	28		6	
49	14.9	140*	X	X	28	28		6	
50	15.2	144*	X	X	28	28	2		
77	23.5	140*	X		44	28		6	
96	29.3	280*	X	X	28	28		6	
112	34.1	280*	X		32	28		6	
143	43.6	280*	X		32	22		6	
169	51.5	280*	X		48	28		6	
197	60.0	280*	X		44	22		6	
214	65.2	280*	X		48	22		6	
268	81.7	280*	X		60	22		6	

Variable Speed									
Belt Speed		RPM From Gearmotor	Mount Package		Pulley Kit		Gearmotor Chart #		
Ft/min	M/min		Top & Bottom	Side	Drive Pulley	Driven Pulley	Light Load	Standard Load	Heavy Load
.4 - 3.4	.1 - 1.0	14	X		22	32		10	
.6 - 5	2 - 1.5	14	X		28	28		10	
.6 - 6	2 - 1.8	29	X		19	32		8, 11	15, 16
1 - 10	.3 - 3.1	29	X		28	28		8, 11	15, 16
1.8 - 14	.5 - 4.5	42	X	X	28	28	3	7, 10	14
1.5 - 15	.5 - 4.6	43	X		28	28		8	15, 16
2.6 - 22	.8 - 6.7	63	X	X	28	28		7	14
2.8 - 23	.8 - 7	42	X		44	28	3	7	14
3.5 - 29	1.1 - 9	83	X		28	28		10	
3 - 30	.9 - 9.2	86	X		28	28		8, 11	15, 16
5.3 - 44	1.6 - 13	125	X	X	28	28		7, 10	14
6 - 49	1.8 - 15	139	X	X	28	28	3		
6 - 60	1.8 - 18	173	X		28	28		8, 11	15, 16
9 - 77	2.8 - 23	139	X		44	28	3		
10 - 88	3.2 - 27	250	X	X	28	28		7, 10	14
10 - 104	3.2 - 32	173	X		48	28		8, 11	15, 16
12 - 121	3.7 - 37	345	X		28	28		8, 11	15, 16
17 - 138	5 - 42	250	X		44	28		7, 10	14
21 - 176	6.4 - 54	500	X	X	28	28		7, 10	14
26 - 264	8.1 - 81	345	X		48	22		8, 11	15, 16
33 - 276	10 - 84	500	X		44	28		7, 10	14

CE RPM from CE/50 Hz gearmotors VFD drive at 63 Max. Hz. output									
Belt Speed	RPM From Gearmotor	Mount Package	Pulley Kit	Gearmotor Chart #					
Ft/min	M/min	Top & Bottom	Side	Drive Pulley	Driven Pulley	Light Load	Standard Load	Heavy Load	
2.4 - 6	.7 - 1.9	23*	X		19	32		9	
4.1 - 10	1.2 - 3.1	23*	X	X	28	28		9	
6 - 15	1.9 - 4.7	35*	X	X	28	28		9	
12 - 31	3.7 - 9.4	70*	X	X	28	28		9	
25 - 62	7.5 - 19	140*	X	X	28	28		9	
39 - 97	12 - 30	140*	X		44	28		9	
49 - 124	15 - 38	280*	X	X	28	28		9	
77 - 195	23 - 59	280*	X		44	28		9	
107-270	33 - 82	280*	X		48	22		9	

Note: Red = Parallel Shaft, Blue = 90°

GANG DRIVE MOUNTING PACKAGES

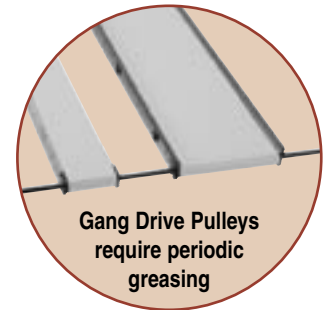
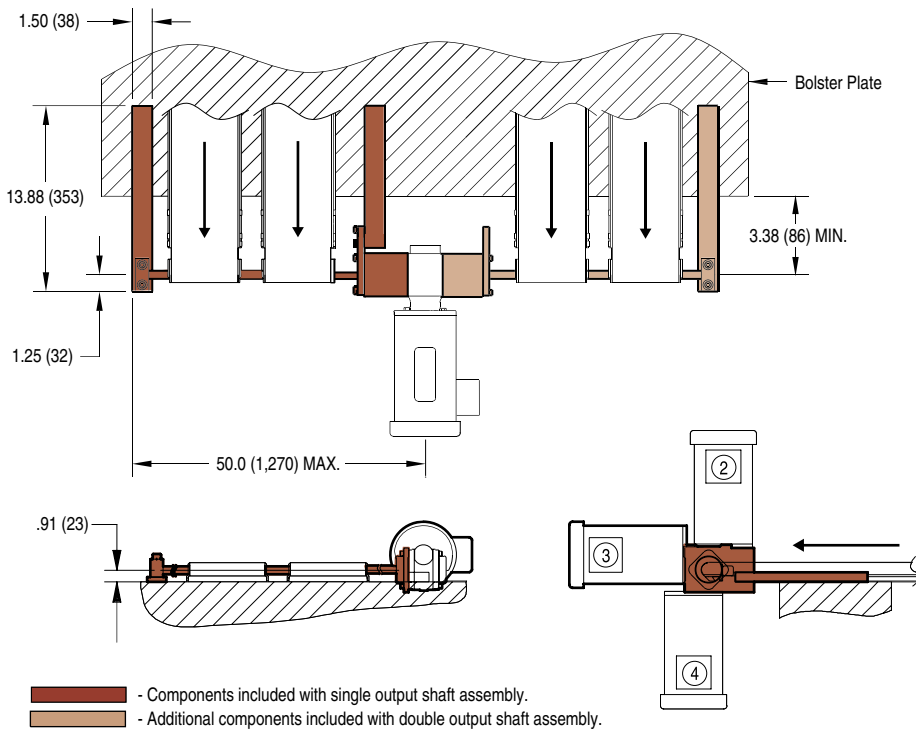

Includes:

Motor mounting bracket, 4" (1219mm) hex shaft, coupling, shaft guard, support block, and support block bracket.

Notes:

- Conveyors cannot be secured to bolster plate
- Order conveyor with gang drive option separately
- Order gearmotor separately (90° Standard & Heavy Load only)
- Positions 2 & 3 recommended

ORDERING INFORMATION

63 M 01

- 01 = Single Output Shaft
- 03 = Double Output Shaft
- Documentation Language
- M** = English, **U** = CE English

Example: 63M01

Description: Gang drive mounting package with English documentation.

Common Drive Set-up

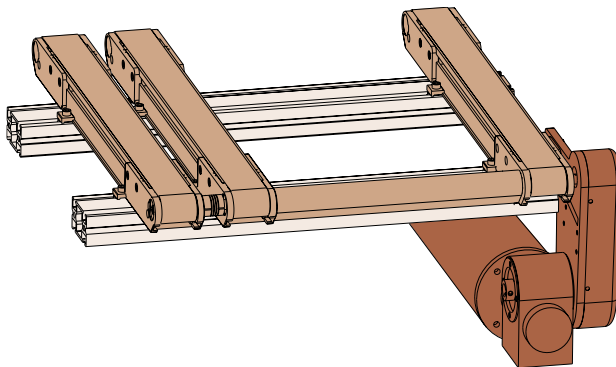

Includes mounting structure, drive shaft, shaft guard and conveyor mounting hardware.

- Order gearmotor & gearmotor mounting package separately
- Consult factory with conveyor and spacing details
- Conveyors are secured to sub-structure at fixed centerline locations

Common drive setups can be customized to your exact specifications. Just provide the conveyor widths, lengths, quantity and centerline spacing. Available with top, bottom or side mount packages for standard or heavy load gearmotors. Consult factory with details.

4100 & 6200 SERIES: GEARMOTORS

Gearmotor Selection Steps

Refer to page 145 for directions on Selecting a Gearmotor Mounting Package and Gearmotor.

	GEARMOTOR TYPE	Conveyor Load - Lbs (Kg)																
		Light Load			Standard Load			Heavy Load										
		10 (4.5)	20 (9.1)	30 (13.6)	40 (18.2)	50 (22.7)	60 (27.3)	70 (31.8)	80 (36.4)	90 (40.9)	100 (45.5)	110 (50)	120 (54.5)					
Belt Speed - Ft/min (M/min)	0-15 (0-4.6)																	
	16-30 (4.9-9.1)																	
	31-45 (9.5-13.7)																	
	46-60 (14-18.3)																	
	61-75 (18.6-22.9)																	
	76-90 (23.2-27.4)																	
	91-110 (27.7-33.5)																	
	111-130 (33.8-39.6)																	
	131-150 (39.9-45.7)																	
	151-175 (46-53.4)																	
	176-200 (53.7-61)																	
	201-225 (61.3-68.6)																	
	226-250 (68.9-76.2)																	
	251-275 (76.5-83.8)																	

Gearmotor Accessories

90° Gearmotor Heat Sink

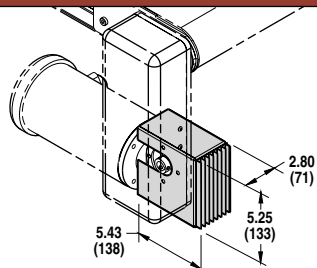

- Reduces gear head surface temperature by up to 50°F (10°C)
- Compatible with Standard and Heavy Load 90° Gearmotors
- Black anodized aluminum

Part Number	Description
694025	90° Gearmotor Heat Sink

Light Load, Fixed Speed

Chart 1		Parallel Shaft					
<ul style="list-style-type: none"> Sealed Gearmotor Totally enclosed, Non-ventilated. Includes Switch, Cord & Overload Protection 115V, 1 Phase Non-reversing 60 Hz 							
Part Number	RPM	Gearmotor Type	1 Ph Hp	1 Ph Kw	1 Ph FLA	in-lbs	N-m
62M036PL411F(N)	42	L	0.03	0.025	0.49	36	4.1
62M015PL411F(N)	100	L	0.03	0.025	0.49	15	1.7

(n) = Reversing capability.

N = No reversing switch. **R** = With reversing switch.

Chart 2		Parallel Shaft						
<ul style="list-style-type: none"> Totally enclosed, Fan Cooled IP44 Protection Rating Non-reversing 50 Hz Order starter separately, See page 159 								
Part Number	RPM	Gearmotor Type	1 Ph Kw	1 Ph FLA	3 Ph Kw	3 Ph FLA	N-m	Starter Chart
62Z028PL421FN	41	L	0.022	0.31	n/a	n/a	2.6	H
62Z028PL4(vp)FN	41	L	n/a	n/a	0.020	.22/.13	3.5	H
62Z008PL421FN	144	L	0.022	0.31	n/a	n/a	0.9	H
62Z008PL4(vp)FN	144	L	n/a	n/a	0.020	.22/.13	1.2	H

(vp) = Voltage and Phase

23 = 230V, 3 phase

43 = 400V, 3 phase

CE Note: When buying a gearmotor only without the starter, the customer must supply their own on/off switch and motor overload protection to comply with the CE Safety Directive.

Light Load, Variable Speed

Chart 3		Parallel Shaft						
<ul style="list-style-type: none"> 130 Volts DC Sealed Gearmotor Totally enclosed, Non-ventilated 300 - 2500 RPM motor Order controller separately, See page 158 								
Part Number	RPM	Gearmotor Type	Hp	Kw	FLA	in-lbs	N-m	Vari - Speed Control Chart
62M060PLD3DEN	42	V	0.06	0.04	0.48	65	7.4	A
62M018PLD3DEN	139	V	0.06	0.04	0.48	21	2.4	A

FLA = Full Load Amperes

Note: 8" (203) and wider conveyors with light load drives should be limited to 8' (2,438) long.

Some motors & gear reducers may normally operate hot to the touch. Consult factory for specific operating temperatures.

4100 & 6200 SERIES: GEARMOTORS

Standard Load, Fixed Speed

Chart 4 90°

- Sealed Gearmotor
- NEMA 42 CZ C Face
- Totally enclosed, Fan cooled
- 115V 1 phase includes switch, Cord & Overload protection
- 208-230/460V 3 phase wiring by others
- 60 Hz
- Order 3 phase starter separately, See page 159

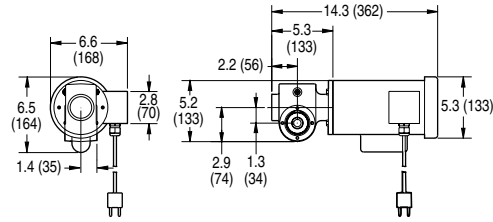

Part Number	RPM	Gearmotor Type	1 Ph Hp	1 Ph Kw	1 Ph FLA	3 Ph Hp	3 Ph Kw	3 Ph FLA	in-lbs	N-m	3 Phase Starter Chart
32M060HL4(vp)F(n)	29	S	0.25	0.19	5	0.25	0.19	1.2/0.6	226	25.5	L
32M040HL4(vp)F(n)	43	S	0.25	0.19	5	0.25	0.19	1.2/0.6	237	26.8	L
32M020HL4(vp)F(n)	86	S	0.25	0.19	5	0.25	0.19	1.2/0.6	142	16	L
32M010HL4(vp)F(n)	173	S	0.25	0.19	5	0.25	0.19	1.2/0.6	78	8.8	L
32M005HL4(vp)F(n)	345	S	0.25	0.19	5	0.25	0.19	1.2/0.6	41	4.6	L

(vp) = Voltage and Phase
 11 = 115V, 1 phase
 23 = 208 - 230 / 460V, 3 phase

(n) = Reversing Capability
 N = No reversing switch.
 R = With reversing switch (115V, 1 phase only)

Chart 5 Parallel Shaft

- Sealed Gearmotors
- Totally enclosed, Fan cooled
- 115V 1 phase includes switch, Cord & Overload protection
- 230V 3 phase wiring by others
- 60 Hz
- Order 3 phase starter separately, See page 159

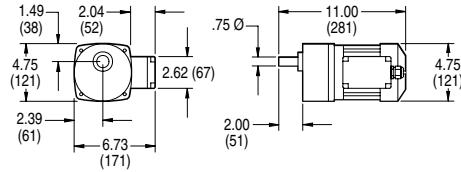

Part Number	RPM	Gearmotor Type	1 Phase				3 Phase				N-m	3 Phase Starter Chart
			Hp	Kw	FLA	in-lbs	Hp	Kw	FLA	in-lbs		
62M180PS4(vp)F(n)	10	S	0.08	0.06	1.2	341	0.17	0.13	1.0	341	38.5	L
62M060PS4(vp)F(n)	29	S	0.17	0.13	1.9	270	0.17	0.13	1.0	270	30.5	L
62M030PS4(vp)F(n)	58	S	0.17	0.13	1.9	135	0.38	0.28	1.9	250	15.3	M
62M020PS4(vp)F(n)	86	S	0.17	0.13	1.9	90	0.38	0.28	1.9	167	10.2	M
62M010PS4(vp)F(n)	173	S	0.17	0.13	1.9	45	0.38	0.28	1.9	115	5.1	M
62M005PS4(vp)F(n)	345	S	0.17	0.13	1.9	25	0.38	0.28	1.9	58	2.8	M

(vp) = Voltage and Phase
 11 = 115V, 1 phase
 23 = 230V, 3 phase

(n) = Reversing Capability
 N = No reversing switch.
 R = With reversing switch (115V, 1 phase only)

Chart 6 CE 90°

- Sealed Gearmotor
- IEC 63 B5 C Face
- IP 55 Protection Rating
- Totally enclosed, Fan cooled
- Non-reversing
- 50 Hz
- Order starter separately, See page 159

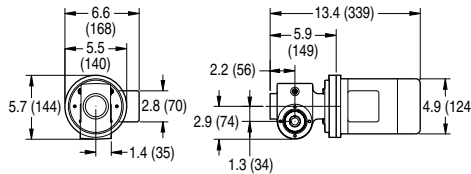

Part Number	RPM	Gearmotor Type	1 Ph Kw	1 Ph FLA	3 Ph Kw	3 Ph FLA	N-m	Starter Chart
62Z060HS4(vp)FN	23	S	0.18	1.6	0.18	1.4/8	26.4	I
62Z040HS4(vp)FN	35	S	0.18	1.6	0.18	1.4/8	28.9	I
62Z020HS4(vp)FN	70	S	0.18	1.6	0.18	1.4/8	19.4	I
62Z010HS4(vp)FN	140	S	0.18	1.6	0.18	1.4/8	10.7	I
62Z005HS4(vp)FN	280	S	0.18	1.6	0.18	1.4/8	5.6	I

(vp) = Voltage and Phase
 21 = 230V, 1 phase
 23 = 230V, 3 phase
 43 = 400V, 3 phase

CE Note: When buying a gearmotor only without the starter, the customer must supply their own on/off switch and motor overload protection to comply with the CE Safety Directive.

Standard Load, Variable Speed

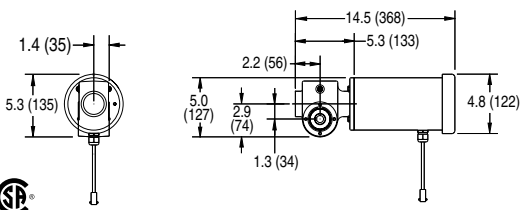

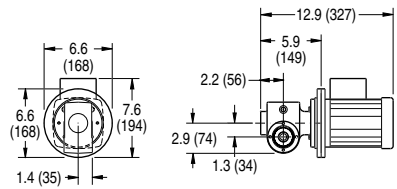

Chart 7		90°								
<ul style="list-style-type: none"> 130 Volts DC Sealed Gearmotor NEMA 42 CZ C Face Totally enclosed, Fan cooled 300 - 2500 RPM motor Order controller separately, See page 158 										
Part Number	RPM	Gearmotor Type	Hp	Kw	FLA	in-lbs	N-m	Vari - Speed Control Chart		
22M060HSD3DEN	42	S	0.33	0.25	2.3	198	22.4	A		
22M040HSD3DEN	63	S	0.33	0.25	2.3	163	18.4	A		
22M020HSD3DEN	125	S	0.33	0.25	2.3	98	11.1	A		
22M010HSD3DEN	250	S	0.33	0.25	2.3	54	6.1	A		
22M005HSD3DEN	500	S	0.33	0.25	2.3	28	3.2	A		

Chart 8		90°								
<ul style="list-style-type: none"> Variable frequency Drive, 6 - 60 Hz Sealed Gearmotor NEMA 56C C Face Totally enclosed, Fan cooled 230/460 Volts, 3 phase Order controller separately, See page 158 										
Part Number	RPM	Gearmotor Type	Hp	Kw	FLA	in-lbs	N-m	Vari - Speed Control Chart		
32M060HL423EN	29	S	0.25	0.19	1.6 / .97	226	25.5	D and E		
32M040HL423EN	43	S	0.25	0.19	1.6 / .97	237	86.8	D and E		
32M020HL423EN	86	S	0.25	0.19	1.6 / .97	142	16	D and E		
32M010HL423EN	173	S	0.25	0.19	1.6 / .97	78	8.8	D and E		
32M005HL423EN	345	S	0.25	0.19	1.6 / .97	41	4.6	D and E		

* = At 60 Hz

Chart 9		CE 90°						
<ul style="list-style-type: none"> Variable Frequency Drive, 25-63 Hz Sealed Gearmotor IEC 63 B5 C Face IP 55 Protection Rating Totally enclosed, Fan cooled 230V, 3 phase Order controller separately, See page 158 								
Part Number	RPM*	Gearmotor Type	3 Ph Kw	3 Ph FLA	N-m*	Vari - Speed		
62Z060HS423EN	23	S	0.18	1.4	26.4	B		
62Z040HS423EN	35	S	0.18	1.4	28.9	B		
62Z020HS423EN	70	S	0.18	1.4	19.4	B		
62Z010HS423EN	140	S	0.18	1.4	10.7	B		
62Z005HS423EN	280	S	0.18	1.4	5.6	B		

* = At 50 Hz

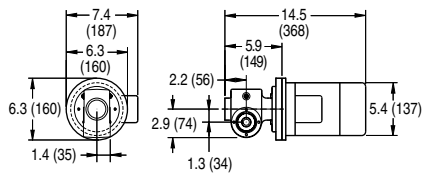
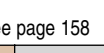
CE Note: When buying a gearmotor only without the starter, the customer must supply their own on/off switch and motor overload protection to comply with the CE Safety Directive.

4100 & 6200 SERIES: GEARMOTORS

Standard Load, Variable Speed

Chart 10

Parallel Shaft

- 130 Volts DC
- Sealed Gearmotor
- Totally enclosed, Non-ventilated
- 300 - 2500 RPM motor
- Order controller separately, See page 158

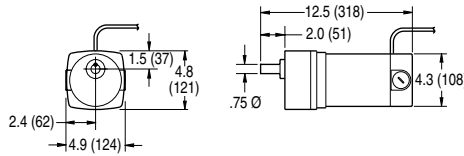

Part Number	RPM	Gearmotor Type	Hp	Kw	FLA	in-lbs	N-m	Vari - Speed Control Chart
62M180PSD3DEN	14	S	0.12	0.09	1	341	38.5	A
62M060PSD3DEN	42	S	0.25	0.19	1.8	270	30.5	A
62M030PSD3DEN	83	S	0.25	0.19	1.8	135	15.3	A
62M020PSD3DEN	125	S	0.25	0.19	1.8	90	10.2	A
62M010PSD3DEN	250	S	0.33	0.25	2.3	72	8.1	A
62M005PSD3DEN	500	S	0.25	0.19	1.8	25	2.8	A

Chart 11

Parallel Shaft

- Variable frequency drive, 10 to 60 Hz
- Sealed Gearmotor
- Totally enclosed, Fan cooled
- 230 Volts / 3 Phase, VFD duty
- Order controller separately, See page 158

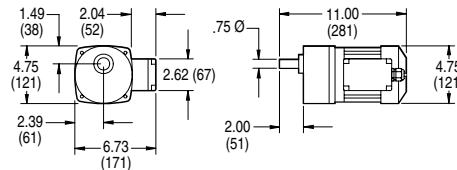

Part Number	*RPM	Gearmotor Type	Hp	Kw	FLA	in-lbs	N-m	Vari - Speed Control Chart
62M180PS423EN	10	S	0.17	0.13	1.0	341	38.5	D and E
62M060PS423EN	29	S	0.17	0.13	1.0	270	30.5	D and E
62M030PS423EN	58	S	0.38	0.28	1.9	250	28.3	D and E
62M020PS423EN	86	S	0.38	0.28	1.9	167	18.9	D and E
62M010PS423EN	173	S	0.38	0.28	1.9	115	13	D and E
62M005PS423EN	345	S	0.38	0.28	1.9	58	6.5	D and E

* = At 60 Hz

Heavy Load, Fixed Speed

Chart 12

90°

- Sealed Gearmotor
- NEMA 56 C Face
- Totally enclosed, Fan cooled
- 115V 1 phase includes switch, Cord & Overload protection
- 208-230/460V 3 phase wiring by others
- 60 Hz
- Order 3 phase starter separately, See page 159

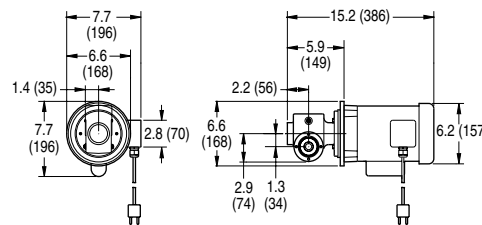

Part Number	RPM	Gearmotor Type	1 Ph Hp	1 Ph Kw	1 Ph FLA	3 Ph Hp	3 Ph Kw	3 Ph FLA	in-lbs	N-m	3 Phase Starter Chart
32M060HS4(vp)F(n)	29	H	0.5	0.37	7.4	0.5	0.37	2.1-2/1	226	25.5	M
32M040HS4(vp)F(n)	43	H	0.5	0.37	7.4	0.5	0.37	2.1-2/1	247	27.9	M
32M020HS4(vp)F(n)	86	H	0.5	0.37	7.4	0.5	0.37	2.1-2/1	248	27.9	M
32M010HS4(vp)F(n)	173	H	0.5	0.37	7.4	0.5	0.37	2.1-2/1	156	17.6	M
32M005HS4(vp)F(n)	345	H	0.5	0.37	7.4	0.5	0.37	2.1-2/1	81	9.1	M

(vp) = Voltage and Phase

(n) = Reversing Capability

11 = 115V, 1 phase

N = No reversing switch.

23 = 208 - 230 / 460V, 3 phase

R = With reversing switch (115V, 1 phase only)

Heavy Load, Fixed Speed

Chart 13		90° Air Gearmotor			
<ul style="list-style-type: none"> Sealed Gearmotor Nema 56 C Face Non-reversing Includes muffler, filter, regulator & lubricator Use with standard load mounting package 					
Part Number	RPM**	Gearmotor Type	HP*	in-lbs **	N-m**
62M060HH000FN	29	H	.5	226	25.5
62M040HH000FN	43	H	.5	247	27.9
62M020HH000FN	86	H	.5	248	27.9
62M020HH000FN	173	H	.5	156	17.6
62M005HH000FN	345	H	.5	81	9.1

* = At 40 PSI (2.8 bar) line pressure
 ** = At 1725 RPM from motor, 25 CFM

Heavy Load, Variable Speed

Chart 14		90°						
<ul style="list-style-type: none"> 90V DC Sealed Gearmotor NEMA 56 C Face Totally enclosed, Fan cooled 300 - 2500 RPM motor Order controller separately, See page 158 								
Part Number	RPM	Gearmotor Type	Hp	Kw	FLA	in-lbs	N-m	Vari - Speed Control Chart
32M060HSD9DEN	42	H	0.5	0.37	5	198	22.4	C
32M040HSD9DEN	63	H	0.5	0.37	5	215	24.3	C
32M020HSD9DEN	125	H	0.5	0.37	5	196	22.1	C
62M010HHD9DEN	250	H	0.75	0.50	7.5	108	12.2	C
62M005HHD9DEN	500	H	0.75	0.50	7.5	56	6.3	C

Chart 15		90°						
<ul style="list-style-type: none"> Variable Frequency Drive, 6 - 60 Hz Sealed Gearmotor NEMA 56 C Face Totally enclosed, Non-ventilated 230/460 Volts, 3 Phase Order controller separately, See page 158 								
Part Number	RPM*	Gearmotor Type	3 Ph Hp	3 Ph Kw	3 Ph FLA	in-lbs*	N-m*	Vari - Speed Control Chart
32M060HS423EN	29	H	0.5	0.37	1.6/8	226	25.5	D and E
32M040HS423EN	43	H	0.5	0.37	1.6/8	247	27.9	D and E
32M020HS423EN	86	H	0.5	0.37	1.6/8	248	27.9	D and E
32M010HS423EN	173	H	0.5	0.37	1.6/8	156	17.6	D and E
32M005HS423EN	345	H	0.5	0.37	1.6/8	81	9.1	D and E

* At 60 Hz

Chart 16		90°						
<ul style="list-style-type: none"> Integrated motor control Variable frequency drive, 10 to 80 Hz Digital display with start/stop and forward/reverse keypad NEMA 56 C face sealed gearmotor Totally enclosed, Fan cooled 115/230 Volts, 1 Phase input voltage 								
Part Number	RPM*	Gearmotor Type	Hp	Kw	Controller Amps	in-lbs*	N-m*	Vari - Speed Control Chart
32M060HS411EC	29	H	0.5	0.37	12.4/6.2	226	25.5	D and E
32M040HS411EC	43	H	0.5	0.37	12.4/6.2	247	27.9	D and E
32M020HS411EC	86	H	0.5	0.37	12.4/6.2	248	27.9	D and E
32M010HS411EC	173	H	0.5	0.37	12.4/6.2	156	17.6	D and E
32M005HS411EC	345	H	0.5	0.37	12.4/6.2	81	9.1	D and E

* At 60 Hz

FLA = Full Load Amperes

4100 & 6200 SERIES: VARIABLE SPEED CONTROLLERS

Variable Speed Controllers

Chart A

- PWM DC control
- Nema 1 enclosure
- Line cord & Motor cord
- On / Off switch for 62MD1134
- Forward / Off / Reverse switch for 62MD1134R
- Speed potentiometer
- Mounting hardware

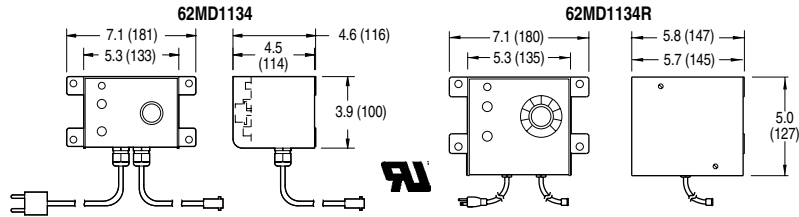

Part Number	Input Volts	Input Phase	Input Hz	Output Volts	*Max Amps	Reversing
62MD1134	115	1	60	130VDC	3.2	No
62MD1134R	115	1	60	130VDC	5	Yes

Chart B



- VFD control
- IP 65 enclosure
- EMC filter
- Speed potentiometer
- Mounting hardware
- Line cord & motor cord

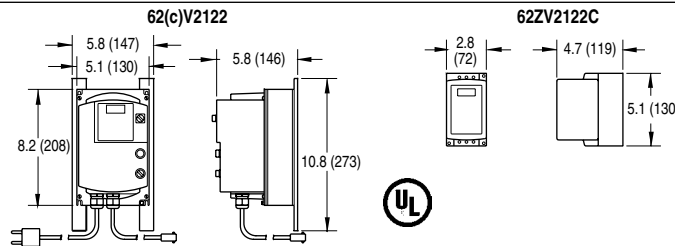

- VFD control
- Chassis mount
- EMC filter
- Wiring by others

Part Number	Input Volts	Input Phase	Input Hz	Output Volts	Out Phase	*Max Kw	Max Amps	Reversing
62(c)V2122	230	1	50	230	3	0.372	2	Yes
62ZV2122C	230	1	50	230	3	0.37	2.2	Yes

(c) = Electrical Configuration
F = CE French

G = CE German
U = CE Great Britain



Note: When buying a chassis mount control, the customer must provide wiring that complies with Ce Safety Directives.

Chart C

- PWM DC control
- NEMA 1 enclosure
- Line cord & Motor cord
- On / Off switch for 62MD1192 & 62MD1193
- Forward / Off / Reverse switch for 62MD1192R & 62MD1193R
- Speed potentiometer
- Mounting hardware

*See FLA from motor charts

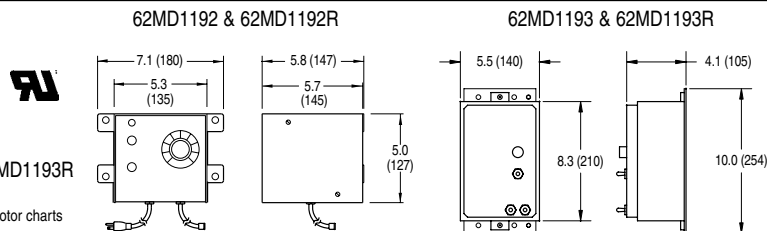

Part Number	Input Volts	Input Phase	Input Hz	Output Volts	*Max Amps	Reversing
62MD1192	115	1	60	90VDC	5	No
62MD1192R	115	1	60	90VDC	5	Yes
62MD1193	115	1	60	90VDC	7.5	No
62MD1193R	115	1	60	90VDC	7.5	Yes

Chart D

- Full feature VFD control
- NEMA 4 enclosure
- Digital display
- Keypad with Start / Stop, Forward / Reverse and speed variations
- Includes cord to motor
- Power to controller by others
- 62MV1122 includes line cord to controller
- Mounting hardware

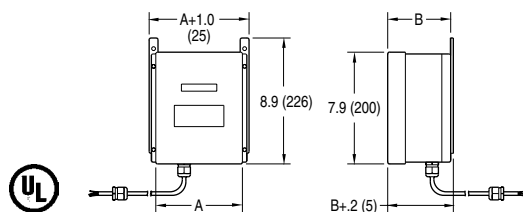

*See FLA from motor charts

Part Number	Input Volts	Input Phase	Input Hz	Output Volts	Output Phase	Max Hp	*Output Amps	Reverse	A Width	B Depth
62MV1122	115	1	60	230	3	.5	2.2	Yes	6.1 (155)	3.8 (96)
62MV2122	230	1	60	230	3	.5	2.2	Yes	6.1 (155)	3.8 (96)
62MV1121	115	1	60	230	3	1	4	Yes	6.1 (155)	4.4 (112)
62MV2121	230	1	60	230	3	1	4	Yes	6.1 (155)	4.4 (112)
62MV2127	230	1	60	230	3	2	6.8	Yes	6.1 (155)	5.3 (134)
62MV2322	230	3	60	230	3	.5	2.2	Yes	4.7 (119)	3.8 (96)
62MV2327	230	3	60	230	3	2	6.8	Yes	6.1 (155)	5.3 (134)
62MV4341	460	3	60	460	3	1	2	Yes	4.7 (119)	3.8 (96)
62MV4347	460	3	60	460	3	2	3.4	Yes	6.1 (155)	4.4 (112)

MANUAL MOTOR STARTERS

Variable Speed Controllers

Chart E

- VFD control
- Nema 1 enclosure
- Line cord and Motor cord
- On / Off switch
- Speed potentiometer
- Mounting hardware
- Forward / Reverse switch

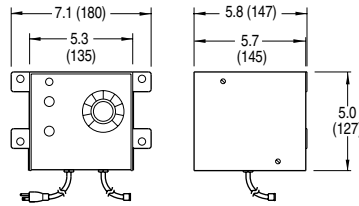

Part Number	Input Volts	Input Phase	Input Hz	Output Volts	Output Phase	Max Hp	*Max Amps	Reversing
62MV1122B	115	1	60	230	3	0.5	2.4	No
62MV1122BR	115	1	60	230	3	0.5	2.4	Yes

Manual Motor Starters

Manual motor starts are manual electrical disconnects that provide motor overload protection and are required by the National Electric Code (NEC) for safe motor operation.

- IP 55 Enclosure
- Push button Start / Stop
- Includes mounting hardware



Illustration A

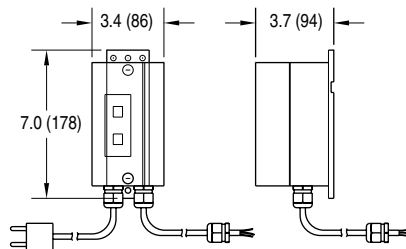

Illustration B

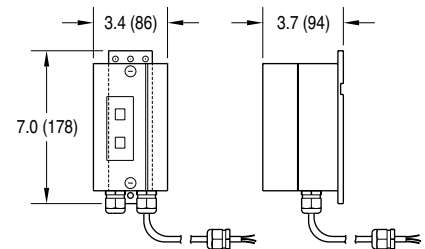

Chart H **CE**

- 230V, 1 phase includes cord, plug & starter .
- 230/400V, 3 phase wiring to starter by others.
- Wiring between motor & starter provided when ordered together.
- 50 Hz

Part Number	In Volts	In Phase	Amp Range	Illustration
62(c)M21H	230	1	.25 - .4	A
62(c)M23H	230	3	.16 - .25	B
62(c)M43H	400	3	.1 - .16	B

Chart I **CE**

- 230V, 1 phase includes cord, plug & starter .
- 230/400V, 3 phase wiring to starter by others.
- Wiring between motor & starter provided when ordered together.
- 50 Hz

Part Number	In Volts	In Phase	Amp Range	Illustration
62(c)M21T	230	1	1.6 - 2.5	A
62(c)M23T	230	3	1.0 - 1.6	B
62(c)M43T	400	3	.63 - 1.0	B



Note: When buying a gearmotor only without the starter, the customer must supply their own on/off switch and motor overload protection to comply with NEC and CE safety directives.

(c) = Electrical Configuration
F = CE French

G = CE German
U = CE Great Britain

Chart L

- 230/460V, 3 phase wiring to starter by others.
- Wiring between motor & starter provided when ordered together.
- 60 Hz

Part Number	In Volts	In Phase	Amp Range	Illustration
62MM23L	230	3	1.0 - 1.6	B
62MM43L	460	3	.4 - .63	B

Chart M

- 230/460V, 3 phase wiring to starter by others.
- Wiring between motor & starter provided when ordered together.
- 60 Hz

Part Number	In Volts	In Phase	Amp Range	Illustration
62MM23M	208 - 230	3	1.6 - 2.5	B
62MM43M	460	3	1.0 - 1.6	B

4100 & 6200 SERIES: SUPPORT STANDS

Quantity Charts

Support Stand Quantity Chart	
Conveyor Length	Number of Supports
2' (610) - 4' (1219)	1*
2' (610) - 6' (1829)	2
7' (2134) - 12' (3658)	3
13' (3962) - 18' (5486)	4
19' (5791) - 24' (7315)	5

*End Drive Conveyors with Single-Post Support Stands only. Requires the use of diagonal bracing, see page 164. Heavy load gearmotors require a minimum of 2 stands to support conveyor and gearmotor package.

Required Return Roller Quantity Chart												
max feet between return rollers												
Conveyor Width	1.75"	2.75"	3.75"	5"	6"	8"	10"	12"	18"	21"	24"	
Flat Belt	8.75	8.5	7.5	7.25	7	6.75	6.5	6	5.5	5	4.5	
Cleated Belt	5.75	5.5	5.25	5	4.75	4.5	4.25	4	3.5	3.25	3	

Quantity of return rollers required = whole number result of : $\frac{\text{conveyor length in feet}}{\text{max distance between return rollers}}$

Example

Description: 6200 flat belt 8" wide x 14' long

$$\frac{14'}{6.75} = 2.07 \quad \mathbf{2 \text{ return rollers required}}$$

6200 Series Return Rollers

Cleated Belt Return Roller

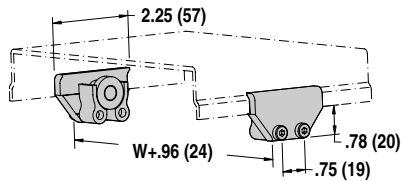

Part Number	Description
490856	Return Roller for 2200 Series, Cleated Belt

Flat Belt Return Roller for 2" to 6" Wide Conveyors

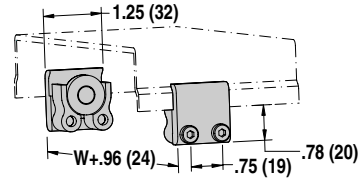

Part Number	Description
490830	Return Roller for 2200 Series 2" (44) - 6" (152) wide Flat Belt conveyors

Flat Belt Return Roller for 8" to 48" Wide Conveyors

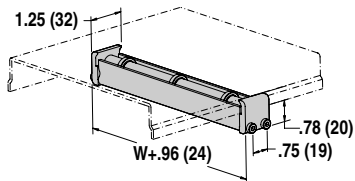

ORDERING INFORMATION

4949 WW

Conveyor width reference: 08 to 48 in 02 increments
Conveyor reference: 4949 = 6200 Series

Example: 494912

Description: Return Roller for a 12" (305) flat belt conveyor.

SUPPORT STANDS

6200 Series Mounting Brackets

Cleated Stand Mounting Bracket

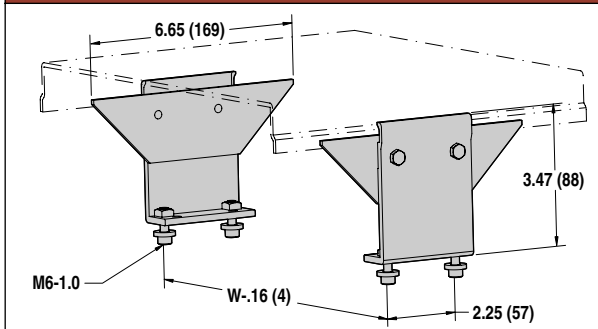

Part Number	Description
450585	Stand Mounting Bracket, Cleated Belt Conveyor

Flat Belt Stand Mounting Bracket

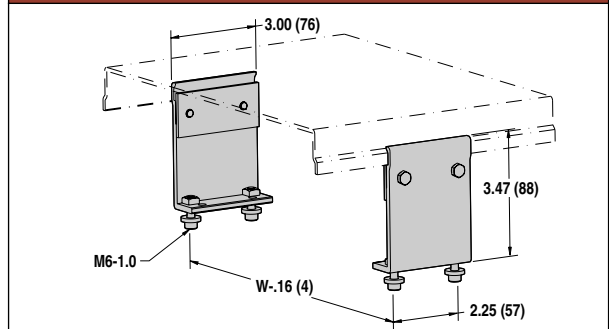

Part Number	Description
450587	Stand Mounting Bracket, Flat Belt Conveyor

Note: Conveyors can be ordered with the required number of mounting brackets. If desired, order additional mounting brackets separately.

4100 Series Mounting Brackets

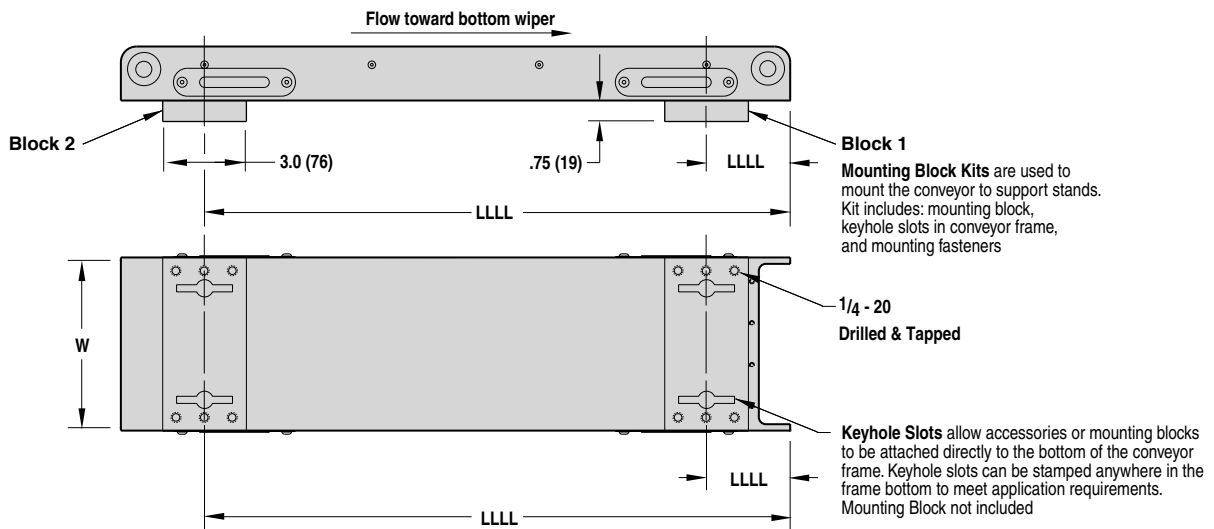

ORDERING INFORMATION

43 - 75 - WW - LLLL

43 - 4100 Series
 75 = Mounting Block Kit, 77 = Keyhole Slot
 WW - Conveyor Width Reference. See conveyor section for sizes
 LLLL - Distance from wiper end in inches

Block 1 Example: 43-75-06-0300

Description: 4100 Series Mounting Block for 6" (152) wide conveyor, centered 3" (76) from wiper end of the conveyor.

Block 2 Example: 43-75-06-3350

Description: 4100 Series Mounting Block for 6" (152) wide conveyor, centered 33.5" (851) from wiper end of the conveyor.

4100 & 6200 SERIES: SUPPORT STANDS

Fixed Height Support Stands

Fixed Foot Model			
Stand Width (WW)	12 (305)	2" (51) increments up to...	48 (1219)
Part # Reference	12	in 02 increments up to...	48
Stand Height (HH)*	15 - 19 (381-483)	in 1" (25) increments up to...	95 - 99 (2413-2515)
Part # Reference	1519	in 0101 increments up to...	9599

Swivel Locking Caster Model			
Stand Width (WW)	12 (305)	2" (51) increments up to...	48 (1219)
Part # Reference	12	in 02 increments up to...	48
Stand Height (HH)*	20 - 24 (508-610)	in 1" (25) increments up to...	68 - 72 (1727-1829)
Part # Reference	2024	in 0101 increments up to...	6872

- Metric fasteners
- 4" (102) Height Adjustment

* Dependent on stand width, stands over 42" (1067) may include outriggers

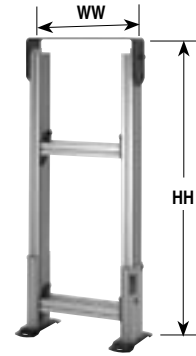

Full width top plate on 12" wide stands only

Adjustable Height Support Stands

Fixed Foot Model											
Stand Width (WW)	12 (305)			2" (51) increments up to...						48 (1219)	
Part # Reference	12			in 02 increments up to...						48	
Stand Height (HH)	12-13 (305-330)	13-15 (330-381)	14-17 (386-432)	16-21 (406-660)	19-26 (483-686)	24-36 (610-914)	30-48 (762-1219)	42-60* (1067-1524)	54-72* (1372-1829)	66-84* (1676-2134)	78-96* (1981-2438)
Part # Reference	1213	1315	1417	1621	1926	2436	3048	4260	5472	6684	7896

Swivel Locking Caster Model										
Stand Width (WW)	12 (305)			2" (51) increments up to...						48 (1219)
Part # Reference	12			in 02 increments up to...						48
Stand Height (HH)	17-18 (432-457)	18-20 (457-508)	19-22 (483-559)	21-26 (533-660)	24-31 (610-787)	29-41 (737-1041)	35-53 (762-1346)	47-65* (1194-1651)	59-77* (1499-1956)	
Part # Reference	1718	1820	1922	2126	2431	2941	3553	4765	5977	

- Metric fasteners

* Dependent on stand width, stands over 42" (1067) tall may include outriggers

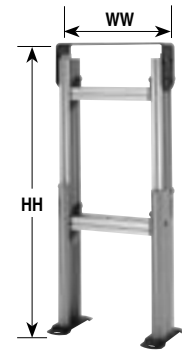

Full width top plate on 12" wide stands only

Single Post & Pillar Support Stands

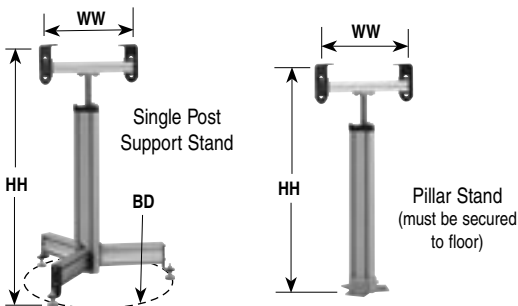

STANDARD SIZES											
Stand Width (WW)	1.75 (44)	2.75 (70)	3.75 (95)	5 (127)	6 (152)	8 (203)	10 (254)	12 (305)	14 (356)	16 (406)	18 (457)
Part# Reference	02	03	04	05	06	08	10	12	14	16	18
Stand Height (HH)	16 - 26 (406-660)		24 - 34 (610-864)		32 - 42 (813-1067)		40 - 50 (1016-1270)		48 - 58 (1219-1473)		
Part# Reference	16		24		32		40		48		
Base Diameter (BD)	24 (610)		27 (686)		30 (762)		33 (838)		36 (915)		

- Casters do not change overall height
- Metric fasteners

Short Support Stands

Fixed Foot Model			
Stand Width (WW)	12 (305)	2" (51) increments up to...	48 (1219)
Part # Reference	12	in 02 increments up to...	48
Stand Height (HH)	06 - 08 (152-203)	in 1" (25) increments up to...	12 - 14 (305-356)
Part # Reference	0608	in 0101 increments up to	1214

Swivel Locking Caster Model			
Stand Width (WW)	12 (305)	2" (51) increments up to...	48 (1219)
Part # Reference	12	in 02 increments up to...	48
Stand Height (HH)	11 - 13 (279-330)	in 1" (25) increments up to...	17 - 19 (432-483)
Part # Reference	1113	in 0101 increments up to...	1719

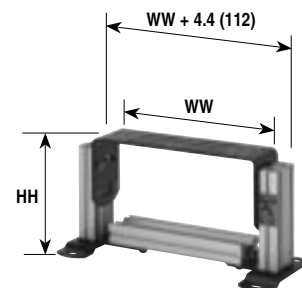

Full width top plate on 12" wide stands only

SUPPORT STANDS

Fully Adjustable Support Stands

Fixed Foot Model

Stand Width (WW)	1.75 (44)	2.75 (70)	3.75 (95)	5 (127)	6 (152)	2" (51) increments up to...	48 (1219)
Stand Width Reference	02	03	04	05	06	02 increments up to...	48
Top Of Belt Range	7 - 19 (179-483)		12 - 31 (305-787)		12 - 43 (305-1097)	12 - 55 (305-1397)	12 - 67 (305-1702)
Stand Height Reference	0719		1231		1243	1255	1267

Swivel Locking Caster Model

Stand Width (WW)	1.75 (44)	2.75 (70)	3.75 (95)	5 (127)	6 (152)	2" (51) increments up to...	48 (1219)
Stand Width Reference	02	03	04	05	06	In 02 increments up to...	48
Top Of Belt Range	12-19 (305-483)		17-31 (432-787)		17-43 (432-1097)	17-55 (432-1397)	17-67 (432-1702)
Stand Height Reference	1219		1731		1743	1755	1767

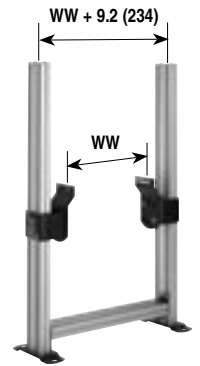

• Metric fasteners

Multi Tier Stands

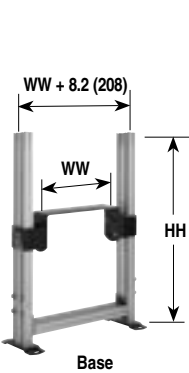

Base

Minimum Tier Height Per Conveyor

2200 Flat Belt	12" (305)
2200 Cleated Belt	15" (381)

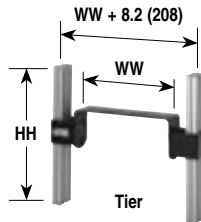

Tier

Full width top plate on 12" wide stands only

Base

Stand Width (WW)	12 (305)	2" (51) increments up to...	48 (1219)
Part # Reference	12	02 increments up to...	48
Stand Height (HH)	12 (305)	2" (51) increments up to...	60 (1524)
Part # Reference	1212	0002 increments up to...	1260

Tier

Stand Width (WW)	12 (305)	2" (51) increments up to...	48 (1219)
Part # Reference	12	02 increments up to...	48
Stand Height (HH)	12 (305)	1" (25) increments up to...	36 (914)
Part # Reference	0712	0001 increments up to...	0736

Note: Do not use with support stands equipped with casters. Support Stands must be anchored to the floor. Do not use if conveyed product overhangs the edge of the conveyor belt due to pinch point created.

ORDERING INFORMATION

S	9	M	TT	WW - HH(min)	HH(max)	F	A
							Assembly (not available for pillar, single post, tall & multi tier stands) P – partially assembled A – Standard assembly (some parts may be separate to accommodate shipping) Feet or Casters (not available for multi tier stands) F – fixed foot pad C – total lock swivel caster Height Reference refer to stand tables top of leg for multi tier Width Reference refer to stand tables Stand Type LH short stand T1 multi tier stand base SP single post Documentation Language M – USA English Stand Style 3 – 2-legged stand 4 – Single post or pillar style
							FH fixed height T2 multi tier stand tier PS pillar support AH adjustable height FT tall fixed* FA fully adjustable AT tall adjustable*

Note: Due to the wide variety of conveyor and stand options along with possible configurations, stability is final setup of the responsibility of the end user.

EXAMPLE: 39MAH12-2126CP

*Tall stands are required when the stand width is 3.5 times the stand height.

4100 & 6200 SERIES: SUPPORT STAND ACCESSORIES

Stand Accessories

Adjustable Tie Bracket

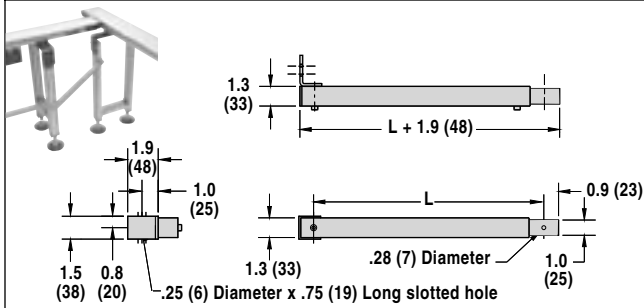

- Compatible with steel and aluminum support stands.
- Secure critical stand and conveyor locations.
- Length (L) adjusts + 0", - 11.25" (286 mm).
- Includes metric mounting hardware.

Part Number	Description
27M400-02	Adjustable Tie Bracket, 2' (610)
27M400-03	Adjustable Tie Bracket, 3' (914)
27M400-04	Adjustable Tie Bracket, 4' (1,219)
27M400-05	Adjustable Tie Bracket, 5' (1,524)
27M400-06	Adjustable Tie Bracket, 6' (1,829)

Bottom Mount Stand Bracket

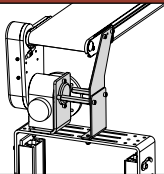

- Bolts to 90° standard load gearmotor
- Includes metric mounting hardware

Part Number	Description
699702M	"L" Bracket only, for 2" to 5" wide conveyors. Bracket Assembly, 06 and wider 2200 conveyors.
6997WWM	

Diagonal Bracing (6200 Series Only)



- For use on steel, aluminum and single post support stands with casters.
- Metric fastener mounting hardware included.
- For use on all stands with casters and any stands over 72" (1829) tall.
- One brace per stand for conveyors up to 24" wide (610)
- Two braces per stand for conveyors over 24" wide (610)

Part Number	Description
710046	for two-legged H style stands up to 30" tall (762)
710047	for two-legged H style stands over 30" tall (762)
710247	for Single Post and Pillar stands over 30" tall (762)

Common Mount Kit (6200 Series Only)

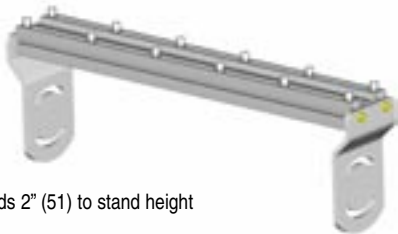

*Adds 2" (51) to stand height

- Stand accessory for mounting multiple conveyors in parallel to one stand.
- Not for use with 4100 Series - see Gang Drive Mounting Package on Page 40

ORDERING INFORMATION

39MCM ww - n
 n = number of conveyors per stand (6 conveyors max.)
 ww = width 12" in 2" increments up to 48"

Tall Support Stands



Tall Stands are the Fixed Height and Adjustable Height Stands as shown with additional outrigger support for added stability. These outriggers are required when the height of the stand exceeds 3.5x its width, and they add 16" to stand width. Tall stands over 6' tall include diagonal bracing.

Note: Due to the wide variety of conveyor and stand options along with possible configurations, stability of the final setup is the responsibility of the end user.

Fine Adjustment Kit

- Provides fine height adjustment via a threaded bolt.
- For use with Fixed Height Stands.



Part #: 710028

4100 & 6200 SERIES: ACCESSORIES

Drive Shaft Accessories

Support Block

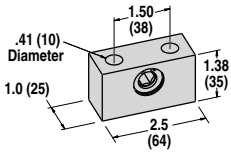

- For 4100 & 6200 Series Gang Drive Conveyors

Part Number	Description
43-33	Support Block, .38 Hex Shaft

Solid Coupling, Hex to Hex

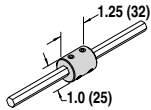

- Includes metric set screws

Part Number	Description
210064M	Solid Coupling, .38 Hex to Hex

Hex Shaft

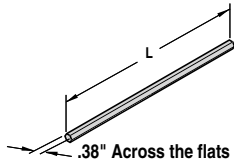

Part Number	Description
23-24	.38" Hex Shaft, steel, 48" (1,219) long
631418	.38" Hex Shaft, stainless steel, 72" (1,829) long

Flexible Coupling

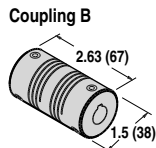
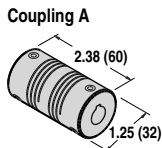

- (A) Includes SAE set screws, (B & C) metric set screws.

Part Number	Description	Coupling
23-27	Flexible Coupling, .50" bore x .38" hex	A
23-28	Flexible Coupling, .63" bore x .38" hex	A
23M29	Flexible Coupling, 12mm bore x .38" hex	B
23M30	Flexible Coupling, 19mm bore x .38" hex	A
23M31	Flexible Coupling, 12mm bore x 12mm bore	B

Clear Cover



- Fits 4100 & 6200 light load top mount and standard & heavy load top and bottom mount packages

Part Number	Description
689498M	Clear cover, ordered with mounting package
689499M	Clear cover, ordered separately

Service Accessories

Grease Adapter



Part Number	Description
45-12	Adapter, 4100 Series
200046M	Adapter, 6200 Series Gang Drive

Tool Kit

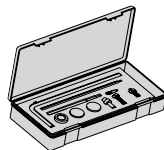

Part Number	Description
4500	Tool Kit, 4100 Series
6500M	Tool Kit, 6200 Series

Grease Sleeves

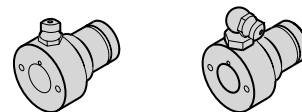

Part Number	Description
622223	Sleeve, 4100 Series, Straight
618898	Sleeve, 4100 Series, 90°
200398M	Sleeve, 6200 Series, Gang Drive Straight, 90°
200399M	Sleeve, 6200 Series, Gang Drive Straight

Conveyor No-Load Torques

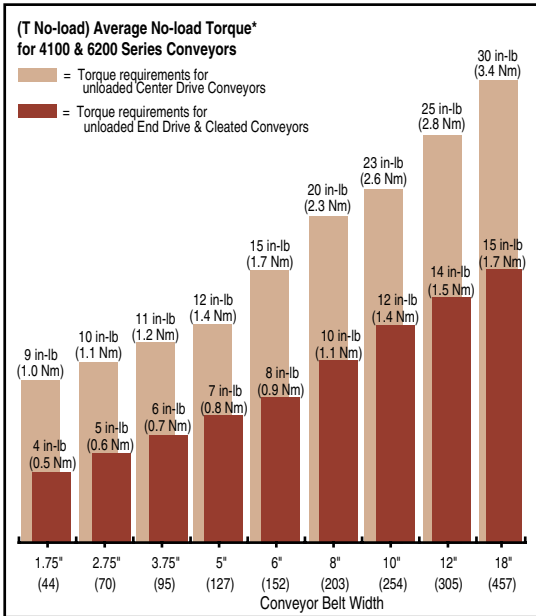

Note: The torque required to overcome the conveyor's initial startup inertia may temporarily exceed the average "no-load" torque by a factor of 2-3 times.

*Stated torques are average values based on Dorner standard belts running at 50 feet (15 meters) per minute.

Maximum Conveyor Load Charts

